

# Make a Wizard's Moon Clock

(Single Pin Escapement Clock)

*(template)*



# WIZARDS MOON CLOCK

## PART 1

### STEP 1

MAKE THIS  
AND GLUE IT  
INTO SHAPE

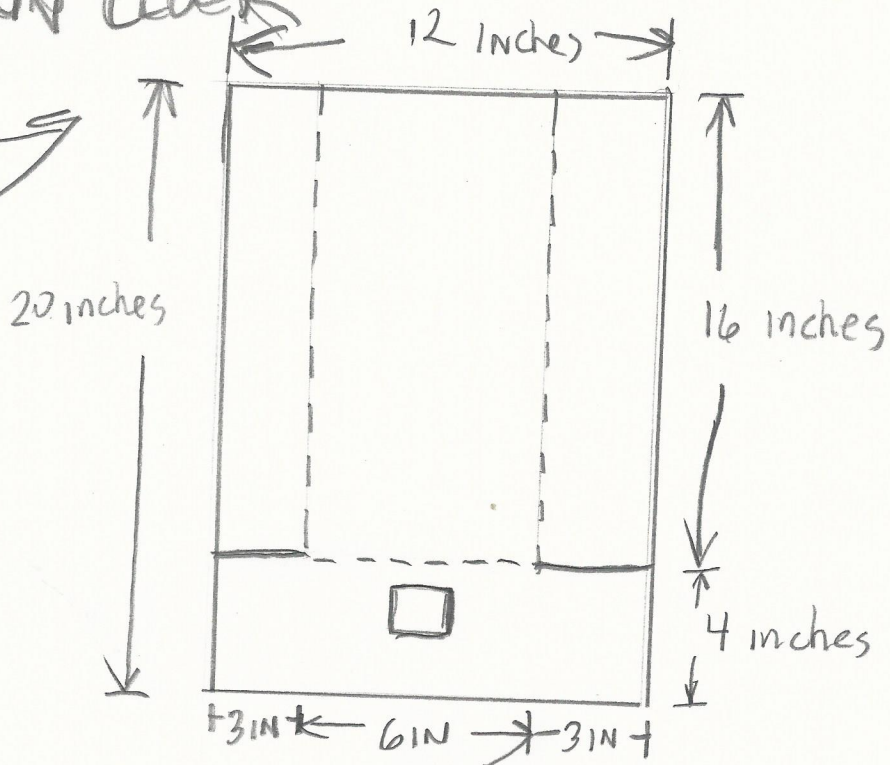

- SOLID LINE IS A CUT ALL THE WAY THROUGH
- DASHED LINE IS A CUT ONLY THROUGH TOP LAYER OF PAPER SO YOU CAN FOLD

FOLD IT AND  
GLUE IT SO IT  
LOOKS LIKE THIS

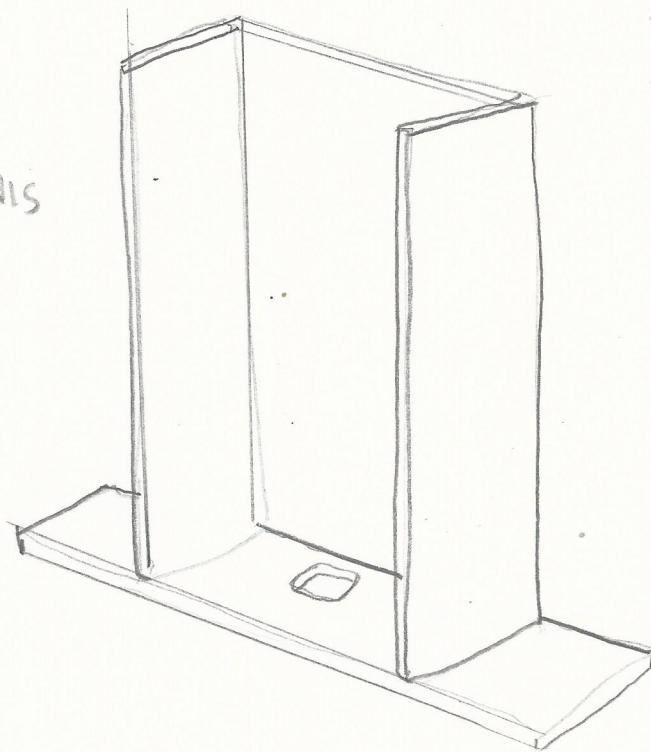

THIS PROJECT  
COPYRIGHT ©  
STORMTHECASTLE.COM  
ALL RIGHTS RESERVED  
2016

PART 2

PART 3

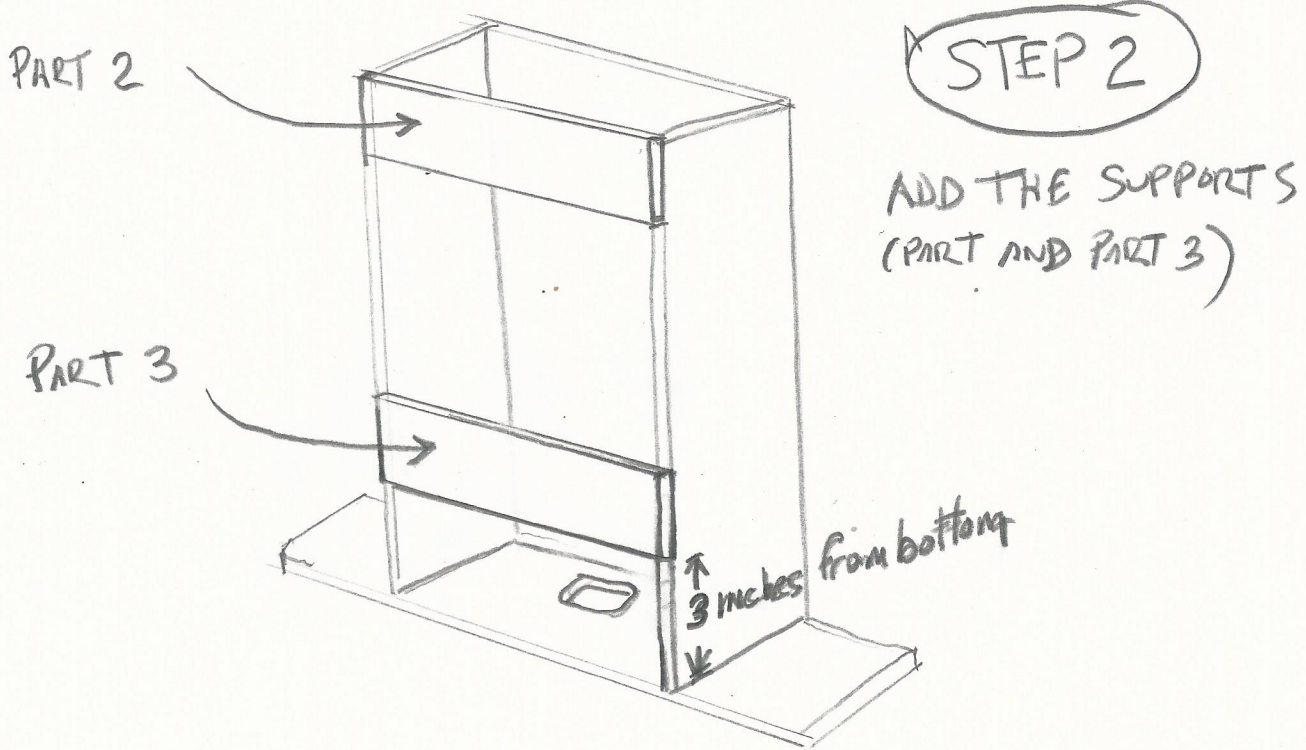



**STEP 3** - MAKE THE DRIVE PIN ASSEMBLY  
GLUE DISCS TOGETHER  
AND GLUE PINS IN

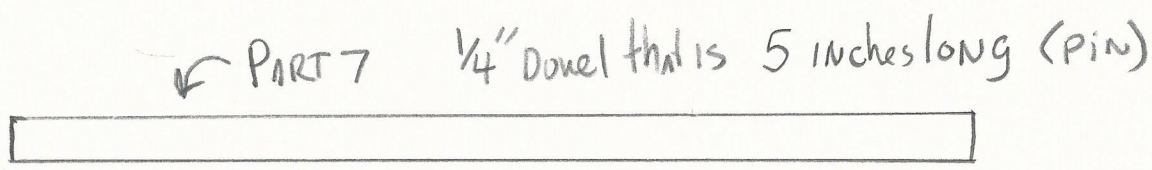
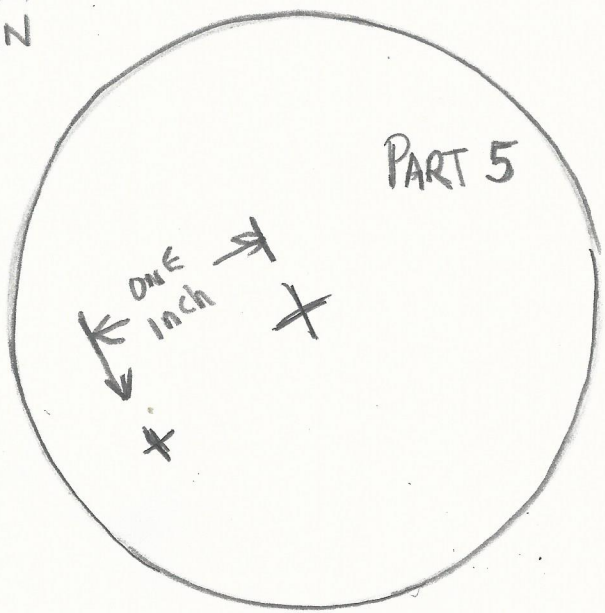
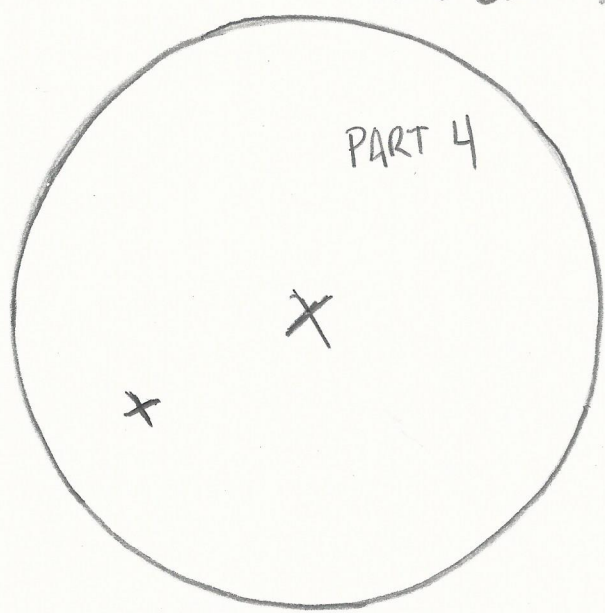

GLUE THESE  
DOWELS IN

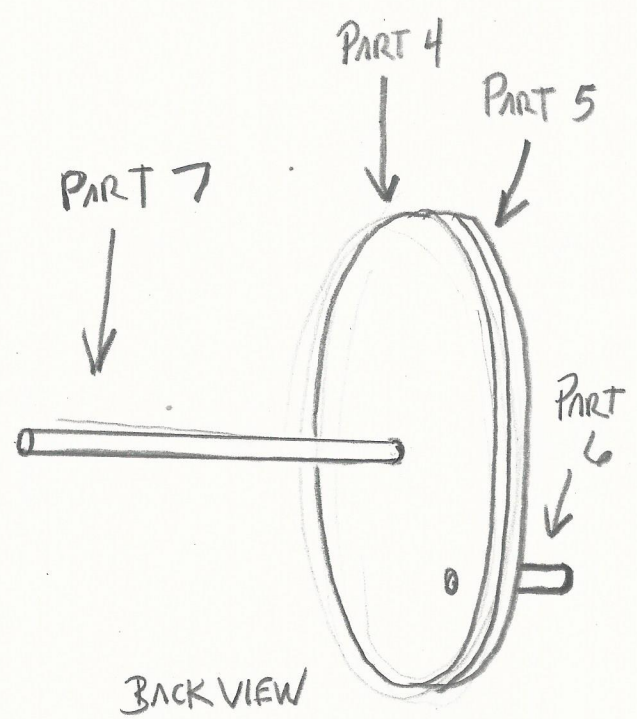
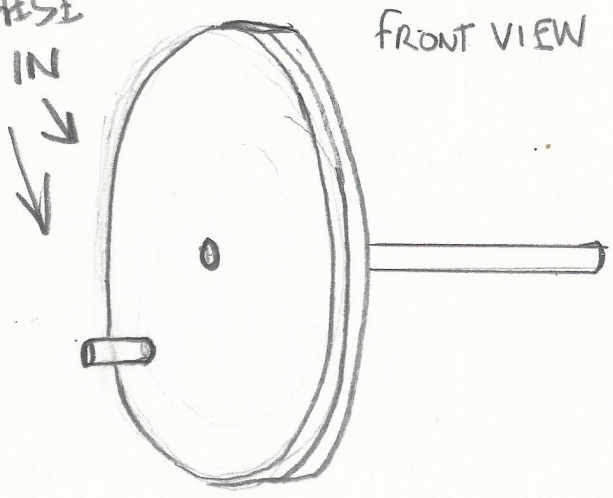

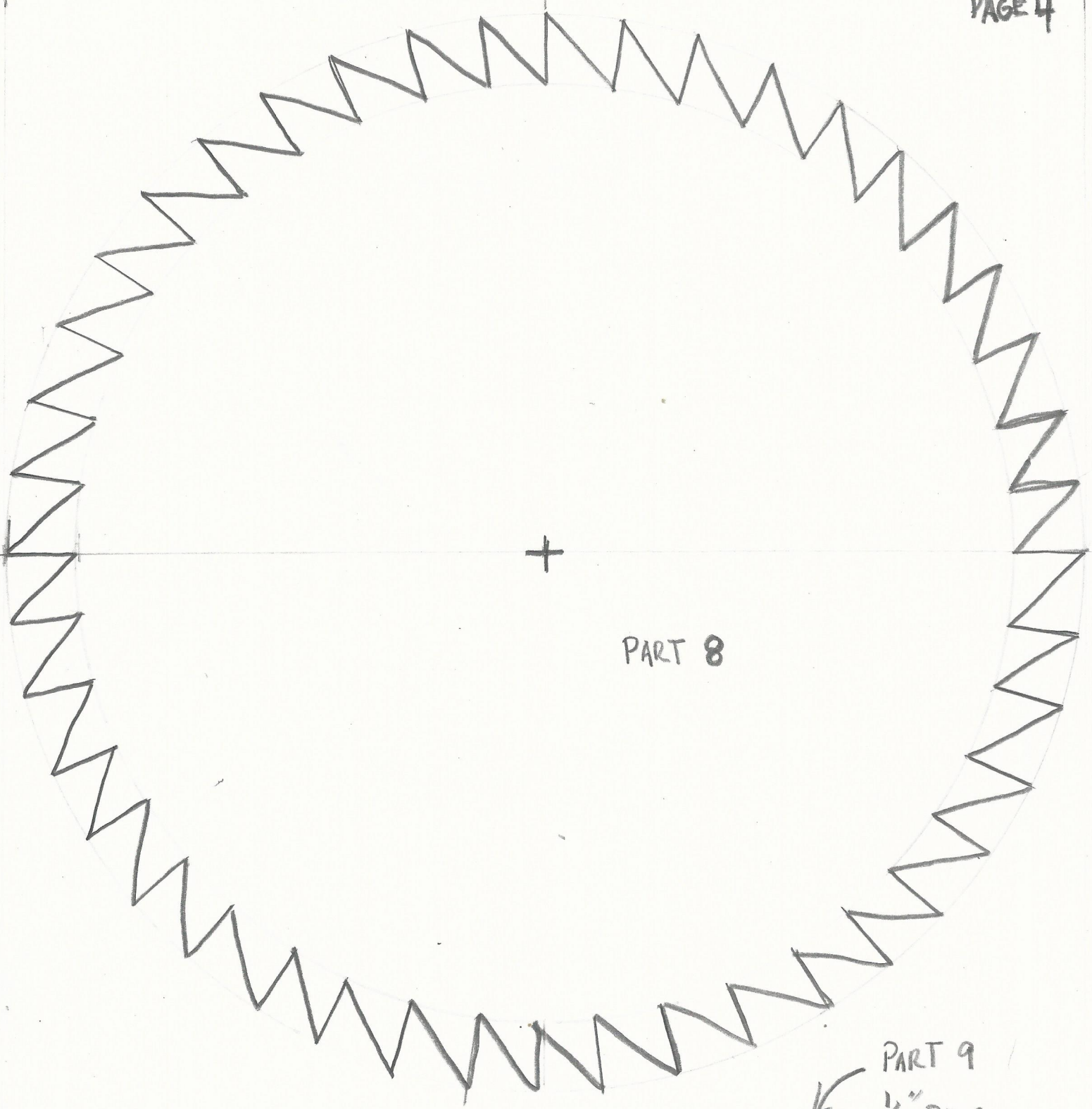

PART 9  
1/4" DOWEL  
6 inches long

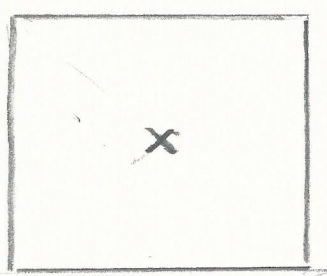

PART 10



STEP 4

Part 11 goes on the opposite side of Part 10

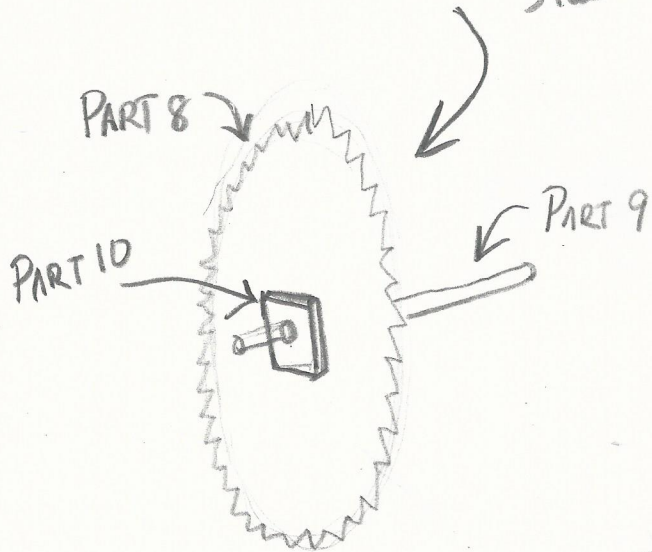

- CUT OUT PART 8
- CUT OUT PART 10
- GLUE PART 10 TO center of 8
- THEN PIERCE THEM in the center with the DOWEL PART 9

\*NOTE: DON'T GLUE PART 9  
It should freely SPIN  
inside the hole

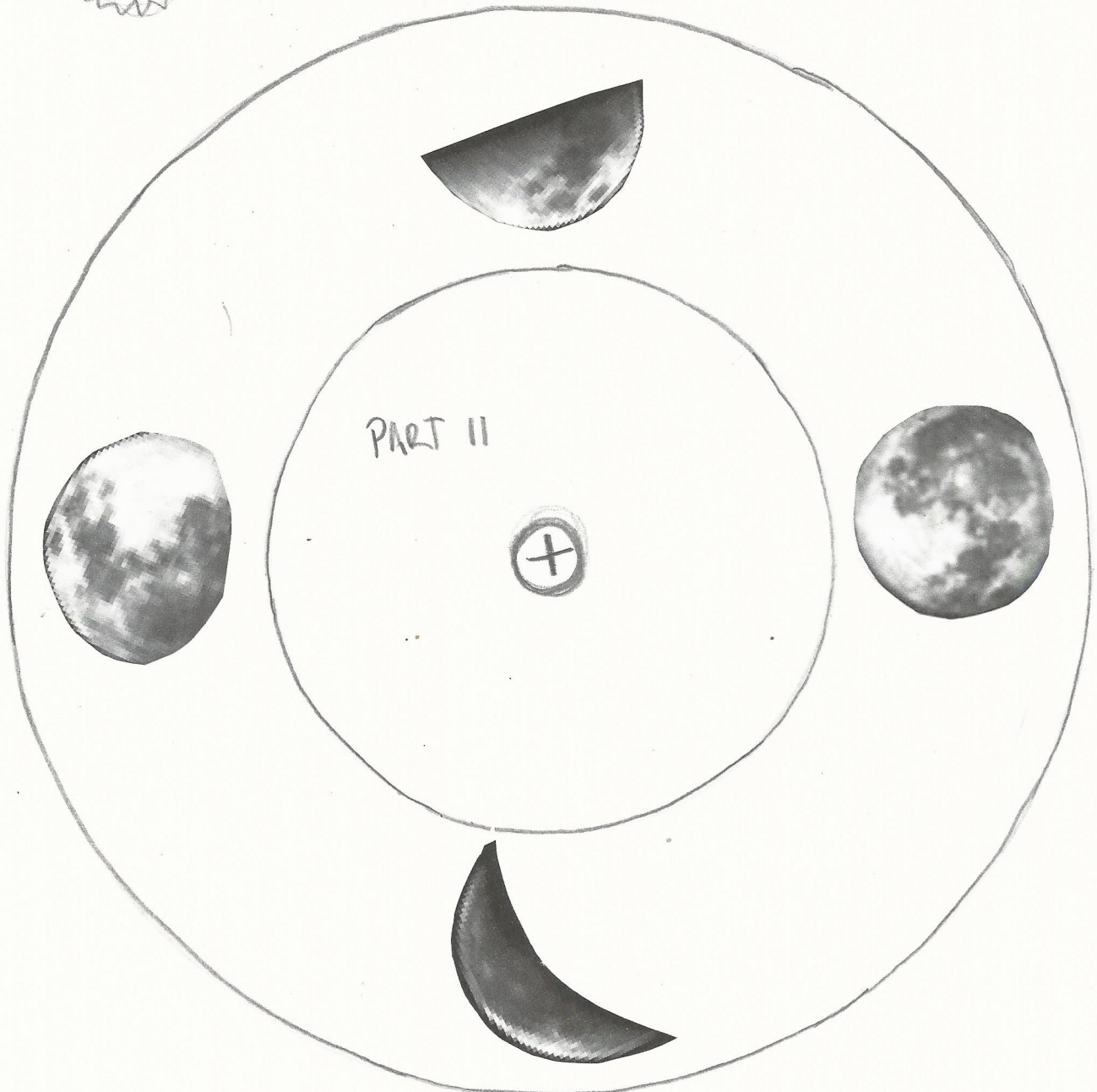



# STEP 4

Extra Page With Blank wheel  
For you to make your own  
Pattern if you want to.

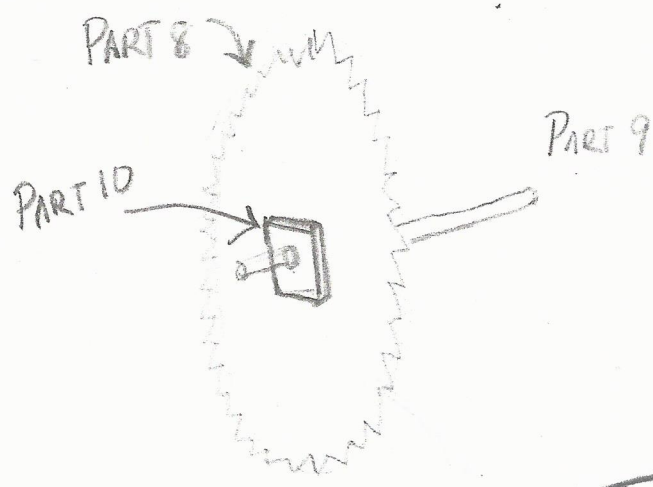

- CUT OUT PART 8
- CUT OUT PART 10
- GLUE PART 10 TO CENTER OF 8
- THEN PIERCE THEM IN THE CENTER WITH THE DOWEL PART 9

\*NOTE: DON'T GLUE PART 9  
It should freely spin  
INSIDE THE HOLE

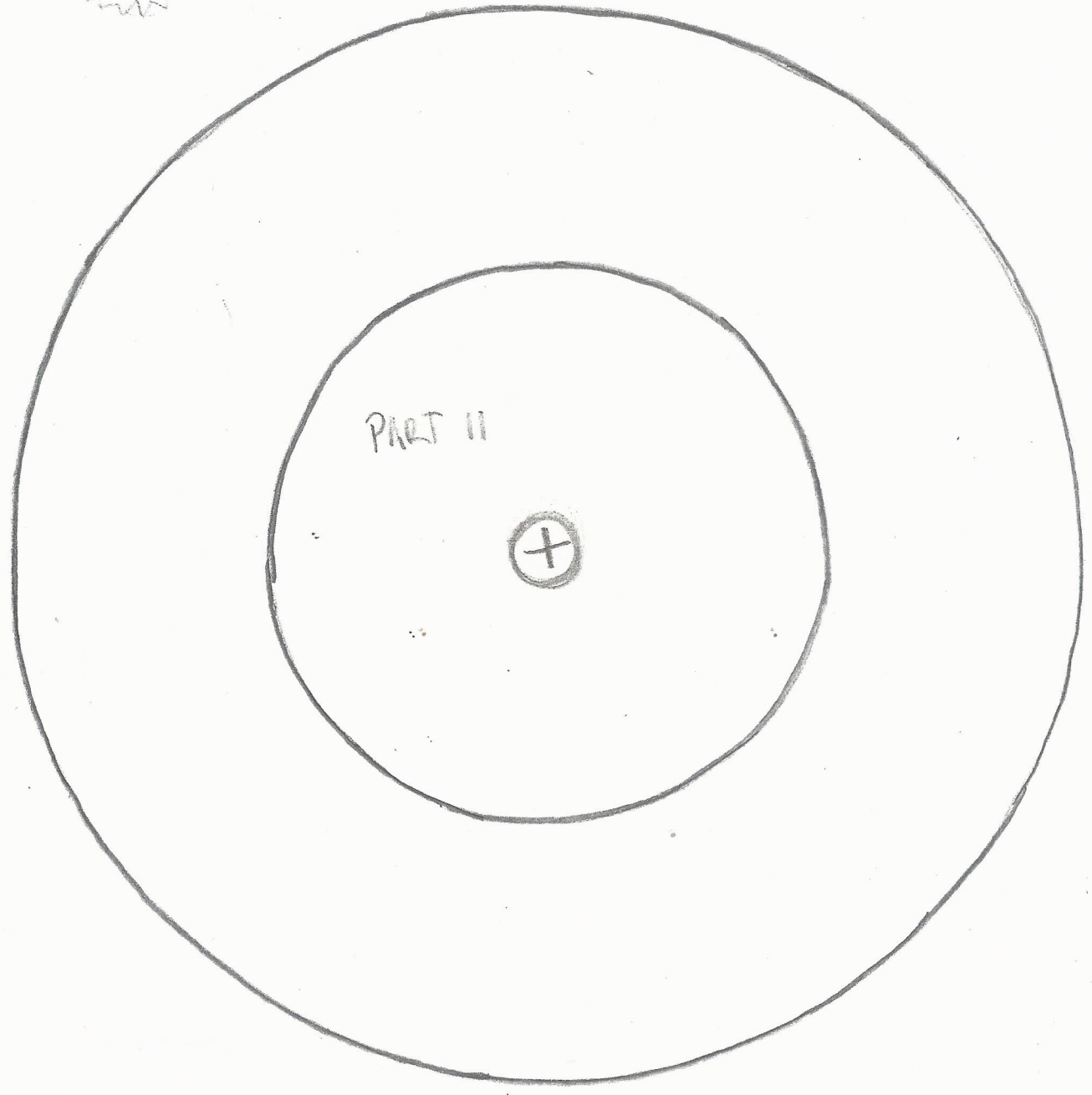

PART 12

PART 13

PART 14

PART 15

PART 16

PART 17

PART 18



# Measurements

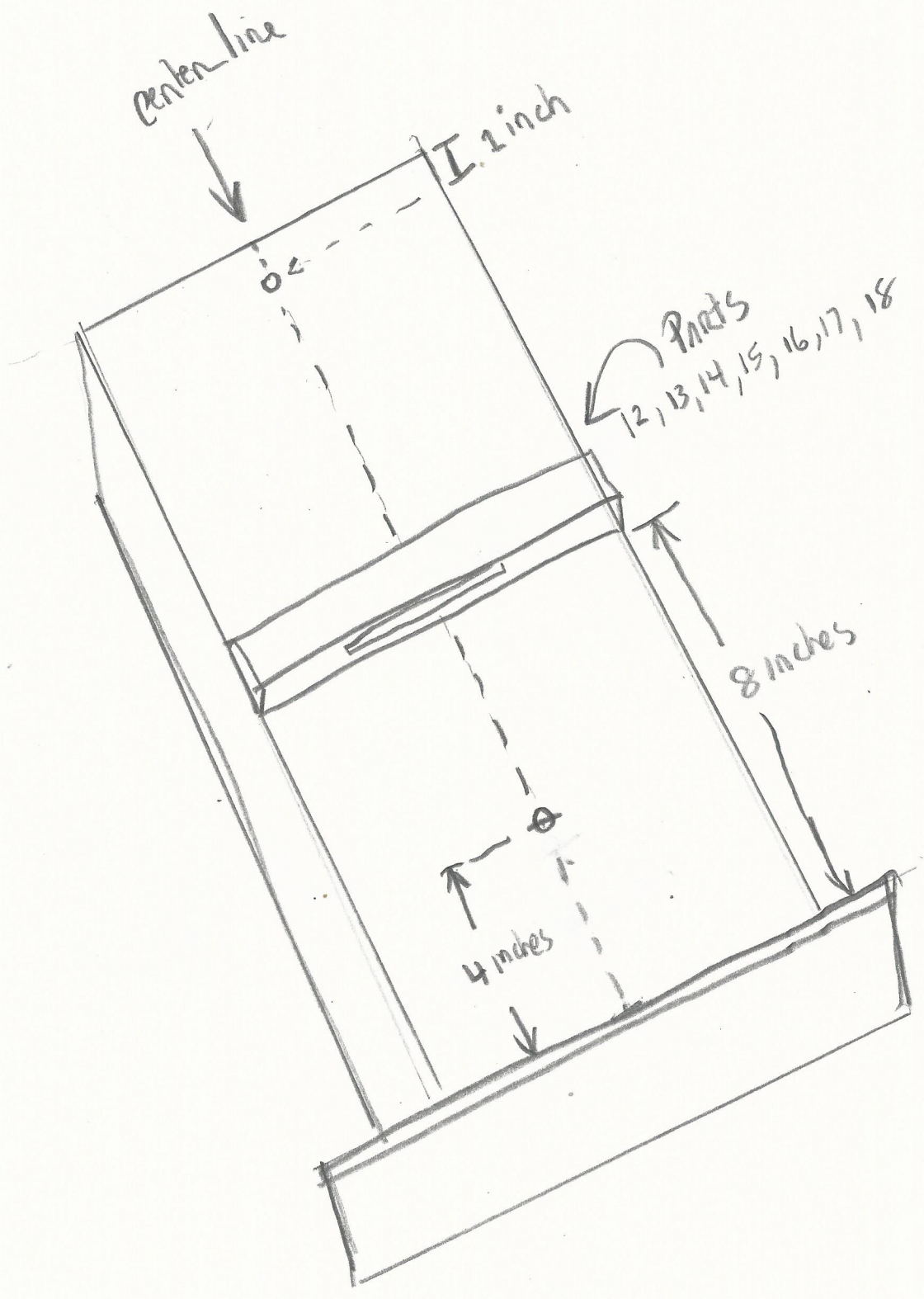

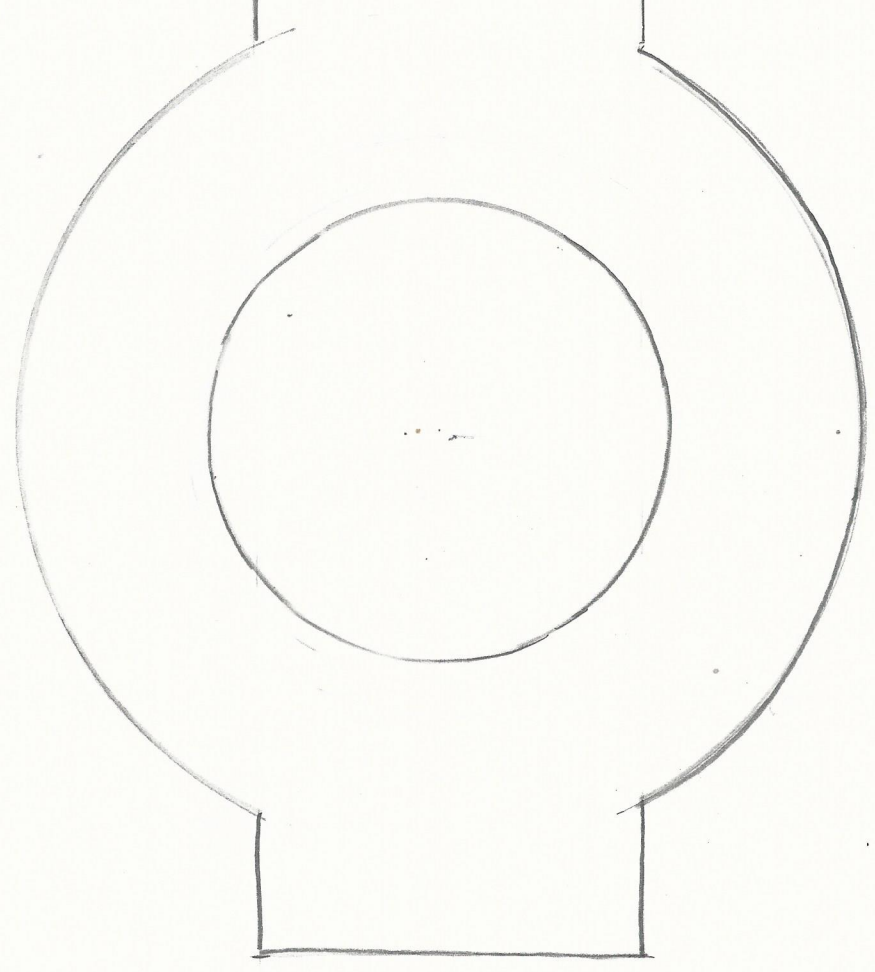
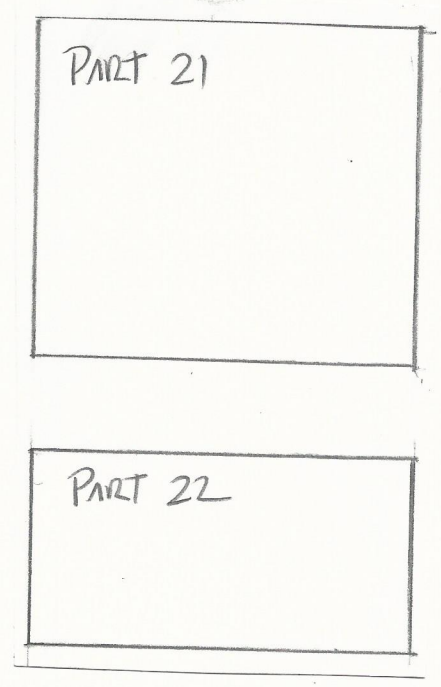
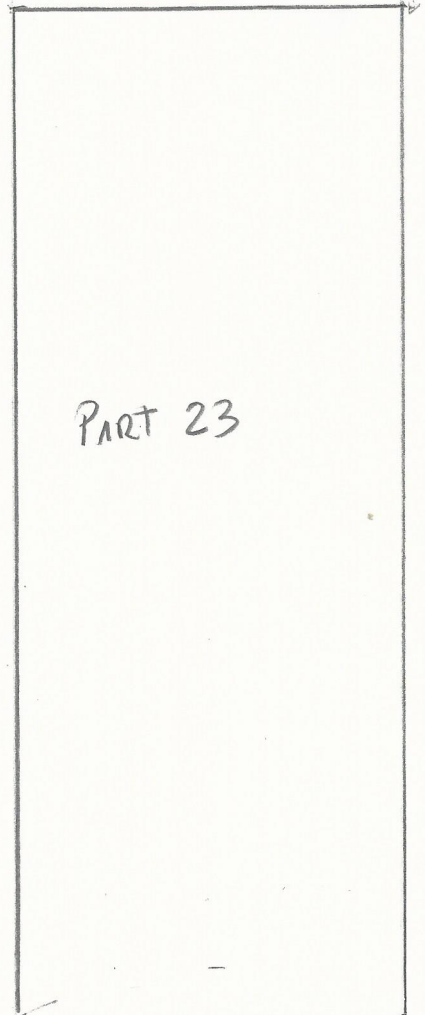
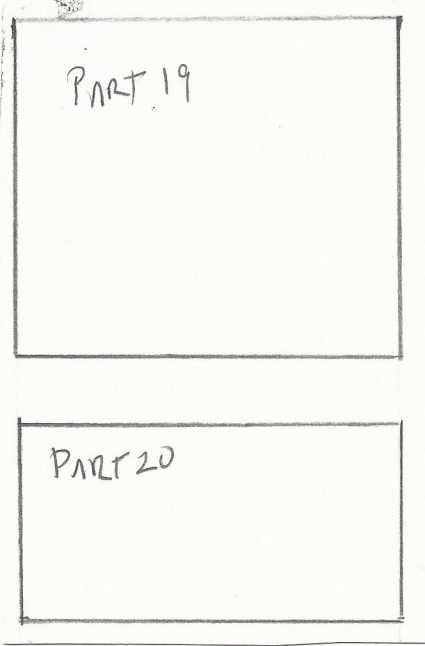

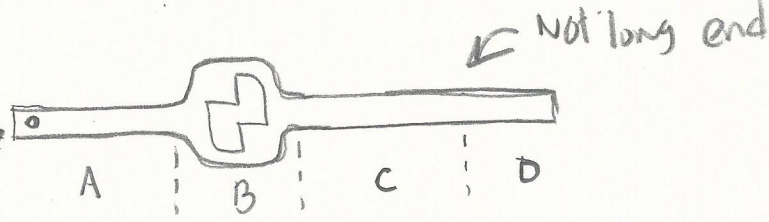

Hole will go here on Short End

Do not pierce hole until you measure it

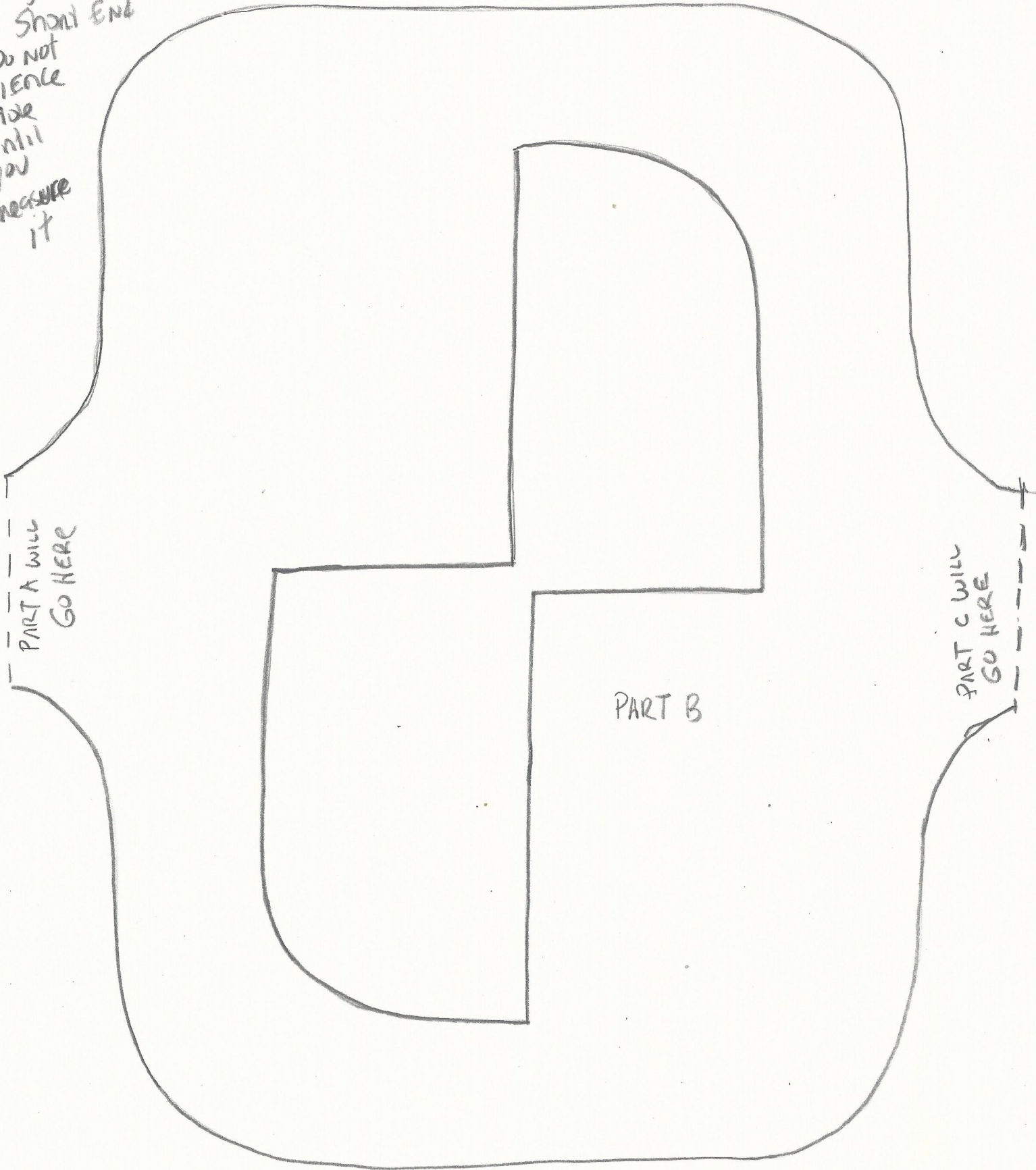

PART A will GO HERE

PART B

PART C will GO HERE



